

TOGGLER® Brand Specialty Anchors from Mechanical Plastics Corp.

- ★ Work in any wall material
- ★ Self contained - no additional fixtures needed
- ★ Fast installation
- ★ Install with electric screw gun
- ★ All specialty anchors are made of a special polypropylene copolymer that is usable in any substrate

PICTURE HOOK ANCHOR/ WIRE HOOK ANCHOR (TH®)

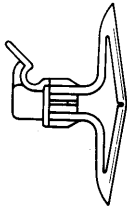

Built-in hook for hanging pictures, also for stringing telephone cable and household electrical wiring. Wire and cable are directly supported by the screw. The picture/wire hook anchor can be used without a screw for light applications (less than 10 lbs. [4.5 kilograms]) in a 3/8" - 1/2" wall grip range when toggled with supplied key into the fully open position. It requires 3/4" (19mm) hollow clearance. The convenient plastic lip guides the picture wire into place assuring easy, safe installation.

Dimensions:

- a 0.15" (3.8mm) hook diameter (flexibility of plastic permits insertion of object of greater diameter)
- b 0.36" (8.9mm) long guiding lip
- c 0.34" (8.6mm) off wall
- d 0.44" (11.2mm) including lip
- e 0.31" (7.9mm) hook width
- f 0.77" (19.6mm) total height including lip
- g 0.46" (11.7mm) flange diameter

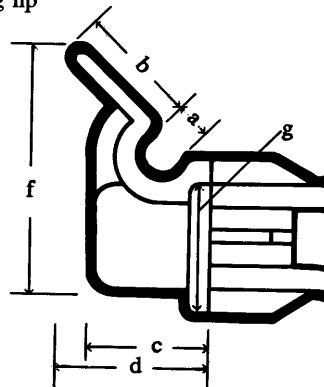
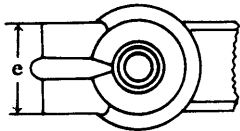

- Minimum wall grip range:
- Minimum screw length:
- Screw type:
- Minimum solid wall hole depth:

- 3/8 - 1/2" (9-13mm)
- 1 1/2" (38mm)
- #6 - 14 (3.5-6mm) sheet metal
- 1 1/4" (32mm)

INSTRUCTIONS:

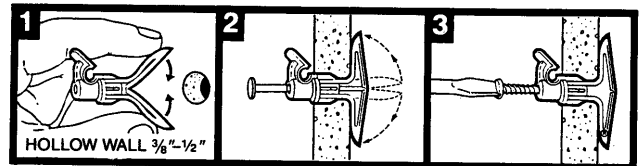

Drill a 5/16" (8mm) hole. Fold anchor, insert in hole and tap flush with wall.

Insert red key to pop anchor open behind wall (except in thick or solid walls). **Do not hammer or force key.** Remove key.

Insert screw and tighten until flush with hook anchor. Use any sheet metal screw from No. 6 (3.5mm) through No. 14 (6mm) with a minimum length of 1 1/2" (39mm).

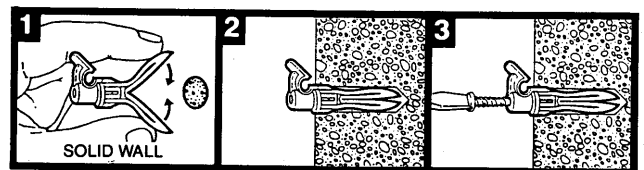

All specialty anchors are installed in the same fashion for both hollow and solid wall applications.

Vertical wall: safe load weight up to 40 pounds (18 kilograms) per TH anchor

SHELVING ANCHOR (TBS1™)

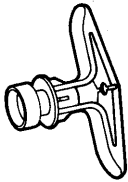

The built-in spacer is made to fit flush within shelving standards (C-channel) to keep them aligned and to keep the anchor from being jacked out during installation. Eliminates the need for finding a stud. Works as an expansion anchor in a stud. May also be used as a picture hook or standoff for installing equipment on hot or wet walls or where ventilation is needed behind installed object.

Dimensions:

a	0.46" (11.7mm)	standoff diameter
b	0.27" (6.9mm)	standoff base diam.
c	0.16" (4.0mm)	standoff height
d	0.14" (3.6mm)	standoff base height
e	0.34" (7.6mm)	standoff inner diam.
f	0.34" (7.6mm)	total standoff height
g	0.56" (14.2mm)	flange diam.

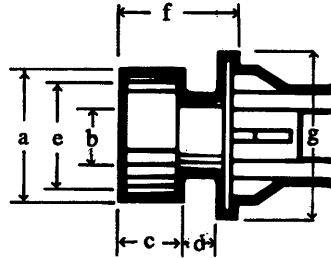

INSTRUCTIONS: Position standard on wall and hang it loosely by a nail from top screw hole. (Gravity will hold standard straight.) Mark the remaining screw hole locations. Remove nail and standard.

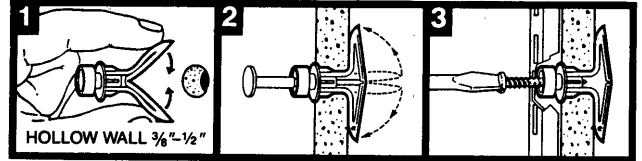

Drill a 5/16" (8mm) hole at each mark. Fold anchors, insert in holes and tap flush with wall.

Insert black key to pop anchors open (except in thick or solid walls). **Do not hammer key.** Remove key.

Place standard over anchors. Insert screws and tighten until flush with standard.

Minimum wall grip range:	3/8-1/2" (9-13mm)
Minimum screw length:	1 3/4" (44mm)
Screw type:	#7 x 1 3/4" (3.5x44mm) flat head (standard shelving bracket screw)
Minimum solid wall hole depth:	1 1/4" (32mm)

PEGBOARD ANCHOR (TBS2™)

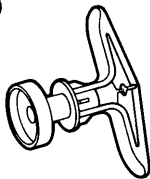

Designed with a spacer to keep pegboard a proper distance from a wall for clearance for peg hooks. Is also ideal for use as a shelving anchor with wide double slotted shelving standards. Eliminates the need for finding a stud. Works as an expansion anchor in a stud. May also be used as a picture hook or standoff for installing equipment on hot or wet walls or where ventilation is needed behind installed object.

Dimensions:

a	0.60" (15.2mm)	standoff diameter
b	0.28" (7.1mm)	standoff base diam.
c	0.17" (4.3mm)	standoff height
d	0.27" (6.9mm)	standoff base height
e	0.47" (11.9mm)	standoff inner diam.
f	0.45" (11.2mm)	total standoff height
g	0.56" (14.2mm)	flange diam.

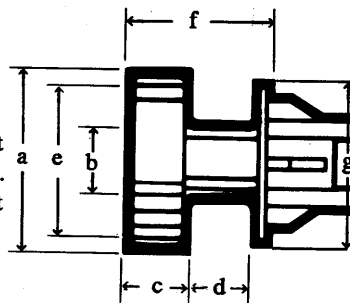

INSTRUCTIONS: Position pegboard on wall and hold it in place with nails in corner peg holes. Mark every 24th hole across and down the pegboard for anchor locations. (Space anchors closer for extra support). Remove pegboard and nails. Drill a 5/16" (8mm) hole at each mark.

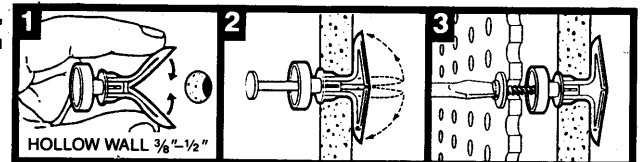

Fold anchors. Insert in holes and tap flush with wall.

Insert black key to pop anchors open behind wall (except in thick or solid walls). **Do not hammer key.** Remove key.

Place pegboard over anchors. Insert screws and tighten.

Minimum wall grip range:	3/8-1/2" (9-13mm)
Minimum screw length:	1 3/4" (44mm)
Screw type:	#8 x 1 3/4" (4x44mm) pan head with washer or screw with head larger than peghole
Minimum solid wall hole depth:	1 1/4" (32mm)

Recommended Use:

- 4 anchors for 2' x 2' (60cm x 60cm) board
- 6 anchors for 2' x 4' (60cm x 120cm) board
- 9 anchors for 4' x 4' (120cm x 120cm) board
- 15 anchors for 4' x 8' (120cm x 240cm) board

WIRE SHELF ANCHOR (TBW™)

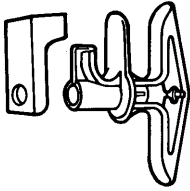

Designed specifically for snap-in installation of wire shelving. Supplied with retainer clip to positively lock shelving in place which prevents tipping of shelf by heavy weight placed near edge. Wire shelf is directly supported by the screw. May also be used as a picture hook. It is particularly well suited for use with Closet Maid® shelving systems and the like.

Dimensions:

- 0.30" (7.6mm) hook diameter; (flexibility of plastic permits insertion of object of greater diameter)
- b 0.65" (16.5mm) rear wall bumper height
- c 0.32" (8.1mm) hook width
- d 0.52" (13.2mm) standoff distance
- e 0.55" (14.0mm) flange diameter
- f 1.06" (26.9mm) total hook height

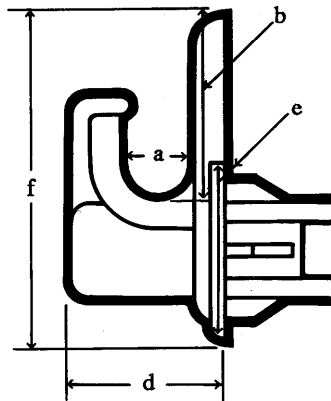
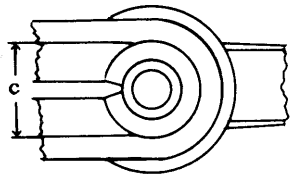
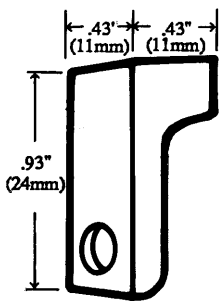

INSTRUCTIONS: Mark a horizontal level line the length of the shelf 5/8" (16mm) below the desired shelf top height. Make a mark 2 1/2" (64mm) from each end and additional marks spaced equally in between. (See chart below.) Drill a 5/16" (8mm) hole at each mark.

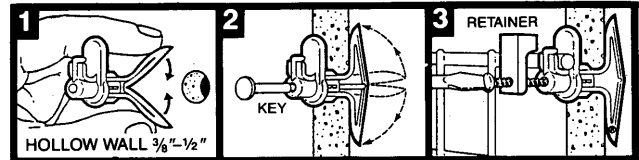

Fold anchors. Insert in holes, and tap flush with wall.

Insert black key to pop anchors open (except in thick or solid walls). **Do not force or hammer key.** Remove key.

Snap shelf onto anchors and let it hang down against wall. Place plastic retainer over anchor, insert screw and tighten. Follow shelf manufacturer's instructions for installing shelf supports and end brackets.

- Minimum wall grip range: 3/8-1/2" (9-13mm)
- Minimum screw length: 1 3/4" (44mm)
- Screw type: #8 x 1 3/4" (4x44mm)
- Minimum solid wall hole depth: 1 1/4" (32mm)

Recommended Use:

- 3 anchors for 24" (60cm) shelf
- 4 anchors for 36" (90cm) and corner shelf
- 5 anchors for 48" (120cm) shelf
- 6 anchors for 60" (150cm) shelf
- 7 anchors for 72" (180cm) shelf

* Closet Maid® is a registered trademark of Clairson International.

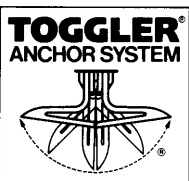

TOGGLER ANCHOR SYSTEM
Div. of MECHANICAL PLASTICS CORP.

110 Richards Avenue • Norwalk, CT 06854 • 888.864.4537 Toll-Free • 203.857.2201 Fax

TOGGLER and typeface, TH, and logo symbol are registered trademarks of Mechanical Plastics Corp.
© 1992, 2012 MPC
SPECTECH 0412